

GENERAL FEATURES

- Environmentally friendly
- Able to operate at 60°C
- Integrated design to ensure the best uniformity and reliability
- Long life and high stability under high temp. environment (no air-con needed)
- Use super-C additives: Deep discharge recovery capability

DIMENSIONS & WEIGHT

Length(mm)	243±1
Width(mm)	187±1
Height(mm)	275±1
Total Height(mm)	275±1
Weight(kg)	30.6±3%

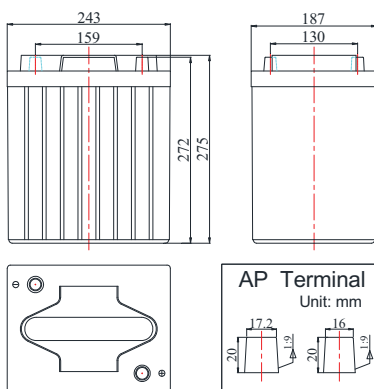

COMPLIED STANDARDS

IEC 60896-21/22	JIS C8704
YD/T799	BS6290 part4
GB/T 19638	UL 1989

APPLICATIONS

- Aerial Work Platform(AWP)/Access
- Material Handling
- Golf/Utility Carts/Vehicle
- Electric Boats/NEV
- Wheel chair&Industrial
- Remote Monitoring&Instrumentation
- Medical Mobility & Marine Vessels
- Renewable Energy(Solar,Wind and Hydro)



TECHNICAL SPECIFICATIONS



Nominal Voltage		6V(6 cells per unit)
Design Floating Life @25°C		15 Years
Nominal Capacity @25°C (20 hour rate@11.25A,10.50V)		225Ah
Capacity @25°C	10 hour rate (20.48A,10.8V)	204.8Ah
	5 hour rate (35.80A,10.5V)	179.0Ah
	1 hour rate (125.1A,9.6V)	125.1Ah
Internal Resistance	Full Charged Battery@25°C	≤3.0mΩ
Ambient Temperature	Discharge	-30°C~60°C
	Charge	-30°C~60°C
	Storage	-30°C~60°C
Max.Discharge Current@25°C		2000A(5s)
Capacity affected by Temperature (10 hr Capacity)	40°C	108%
	25°C	100%
	0°C	90%
	-15°C	70%
Self-Discharge@25°C per Month		3%
Charge (Constant Voltage) @25°C	Standby Use	Initial Charging Current Less than 40.5A Voltage 6.8-6.9V
	Cycle Use	Initial Charging Current Less than 40.5A Voltage 7.2-7.45V

BATTERY DISCHARGE TABEL

Discharge Constant Current per Cell (Amperes at 25°C)

F.V/Time	15min	30min	45min	1h	2h	3h	5h	8h	10h	20h	100h
1.60V	289.6	185.0	135.9	125.1	79.4	55.8	37.8	25.0	22.28	11.93	2.70
1.67V	284.4	181.6	133.4	122.6	77.9	54.7	37.1	24.5	21.83	11.70	2.66
1.70V	279.0	178.2	131.0	120.4	76.5	53.8	36.5	24.1	21.38	11.48	2.59
1.75V	273.8	174.8	128.5	118.1	74.9	52.7	35.8	23.6	21.15	11.25	2.54
1.80V	263.3	168.1	123.5	113.6	72.0	50.6	34.4	22.7	20.48	11.14	2.50

Discharge Constant Power per Cell (Watts at 25°C)

F.V/Time	15min	30min	45min	1h	2h	3h	5h	8h	10h	20h	100h
1.60V	557.3	356.0	261.7	240.1	152.6	107.1	72.9	47.9	43.0	23.3	5.20
1.67V	547.2	349.4	256.7	235.8	149.9	105.3	71.6	47.3	42.1	22.8	5.09
1.70V	537.1	342.9	252.0	231.3	147.2	103.3	70.2	46.4	41.4	22.6	5.00
1.75V	527.0	336.4	247.3	227.0	144.2	101.3	68.9	45.5	40.5	22.3	4.91
1.80V	506.7	323.6	237.8	218.3	138.8	97.4	66.4	43.7	38.9	21.6	4.82

Note The above data are average values, and can be obtained within 3 charge/discharge cycles. These are not minimum values. Cell and battery designs/specifications are subject to modification without notice. Contact **CBB** for the latest information.

PERFORMANCE CHARACTERISTICS

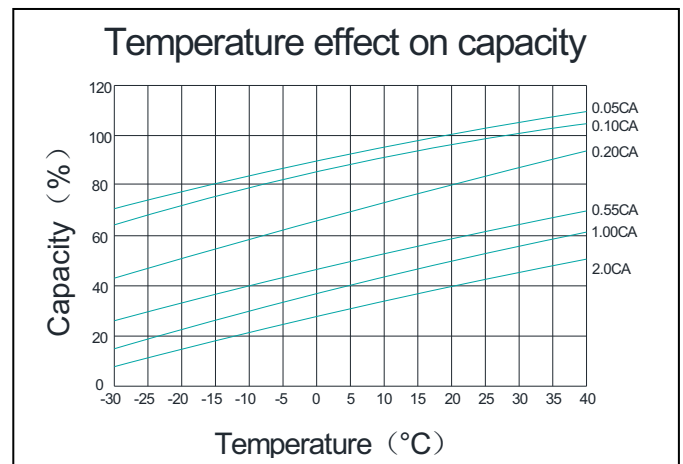
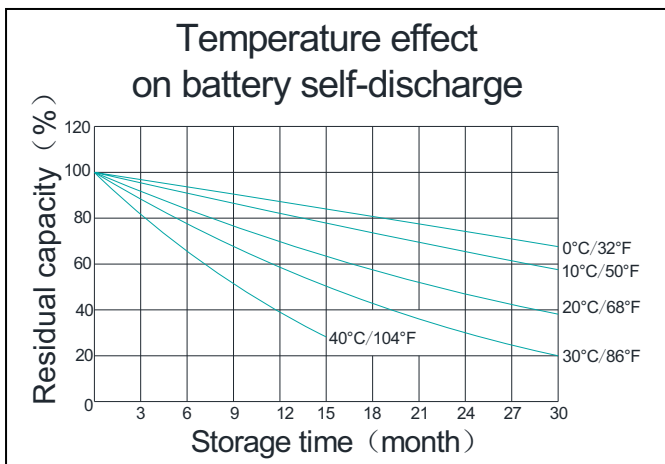
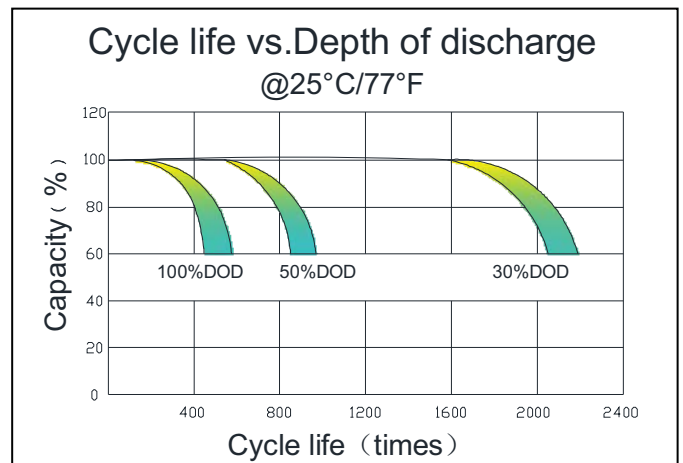
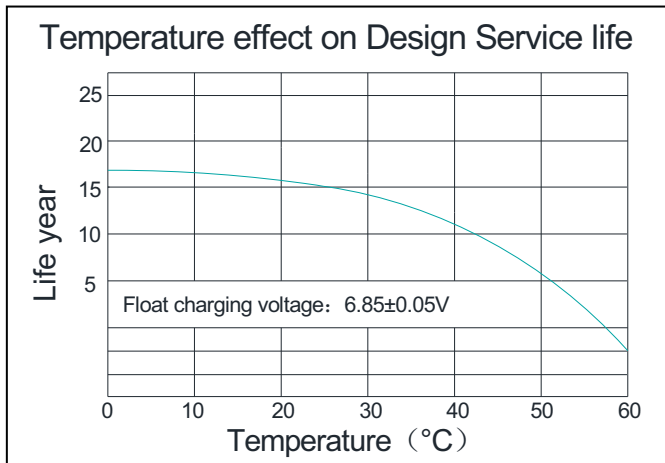
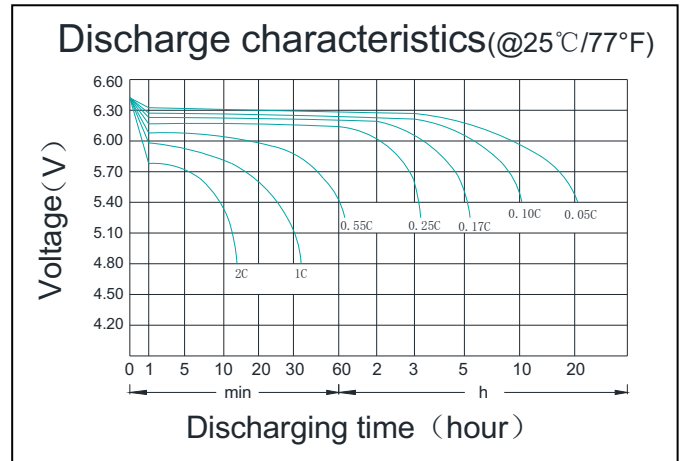
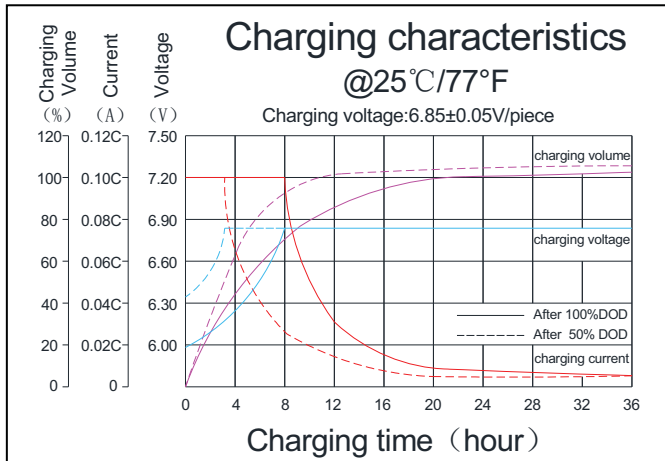

BATTERY CONSTRUCTION

Component	Positive plate	Negative plate	Container & Cover	Safety valve	Terminal	Separator	Electrolyte	Pillar seal
Features	Thick high Sn low Ca grid with special paste	Balanced Pb-Ca grid for improved recombination efficiency	ABS (UL94-V0 optional)	Flame Si-Rubbeand aging resistancer	Female Copper Insert AP(torque:6 ~8N.m)	Advanced AGM separator for high pressure cell design	Dilute high purity sulphuric acid with fumed Silica gel	Two layers epoxy resin seal

CBB Battery Technology Co.,Ltd.

RM504,55 Hanxing Zhong Road,Zhongcun, Panyu,Guangzhou 511495 China
 Tel: +86-020-84888946 Fax: +86-020-62824569

Koyama®

www.cbb-battery.com