

GENERAL FEATURES

- Environmentally friendly
- Able to operate at 60°C
- Integrated design to ensure the best uniformity and reliability
- Long life and high stability under high temp. environment (no air-con needed)
- Use super-C additives: Deep discharge recovery capability

DIMENSIONS & WEIGHT

Length(mm)	165±1
Width(mm)	126±1
Height(mm)	174±1
Total Height(mm)	174±1
Weight(kg)	8.1±3%

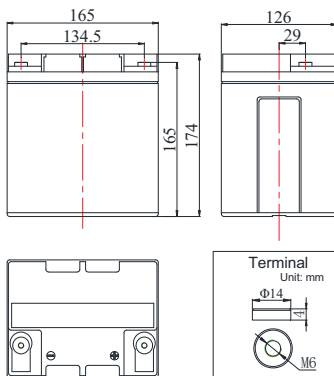

COMPLIED STANDARDS

IEC 60896-21/22	JIS C8704
YD/T799	BS6290 part4
GB/T 19638	UL 1989

APPLICATIONS

- Aerial Work Platform(AWP)/Access
- Material Handling
- Golf/Utility Carts/Vehicle
- Electric Boats/NEV
- Wheel chair&Industrial
- Remote Monitoring&Instrumentation
- Medical Mobility & Marine Vessels
- Renewable Energy(Solar,Wind and Hydro)



TECHNICAL SPECIFICATIONS



Nominal Voltage		12V(6 cells per unit)
Design Floating Life @25°C		15 Years
Nominal Capacity @25°C(20 hour rate@1.30A,10.50V)		26Ah
Capacity @25°C	10 hour rate (2.37A,10.8V)	23.7Ah
	5 hour rate (4.1A,10.5V)	20.5Ah
	1 hour rate (14.5A,9.6V)	14.5Ah
Internal Resistance	Full Charged Battery@25°C	≤13.3mΩ
Ambient Temperature	Discharge	-30°C~60°C
	Charge	-30°C~60°C
	Storage	-30°C~60°C
Max.Discharge Current@25°C		260A(5s)
Capacity affected by Temperature (10 hr Capacity)	40°C	108%
	25°C	100%
	0°C	90%
	-15°C	70%
Self-Discharge@25°C per Month		3%
Charge (Constant Voltage) @25°C	Standby Use	Initial Charging Current Less than 5.8A Voltage 13.6-13.8V
	Cycle Use	Initial Charging Current Less than 5.8A Voltage 14.4-14.9V

BATTERY DISCHARGE TABEL

Discharge Constant Current per Cell (Amperes at 25°C)

F.V/Time	15min	30min	45min	1h	2h	3h	5h	8h	10h	20h	100h
1.60V	33.5	21.4	15.7	14.5	9.2	6.4	4.4	2.9	2.57	1.38	0.31
1.67V	32.9	21.0	15.4	14.2	9.0	6.3	4.3	2.8	2.52	1.35	0.31
1.70V	32.2	20.6	15.1	13.9	8.8	6.2	4.2	2.8	2.47	1.33	0.30
1.75V	31.6	20.2	14.8	13.7	8.7	6.1	4.1	2.7	2.44	1.30	0.29
1.80V	30.4	19.4	14.3	13.1	8.3	5.9	4.0	2.6	2.37	1.29	0.29

Discharge Constant Power per Cell (Watts at 25°C)

F.V/Time	15min	30min	45min	1h	2h	3h	5h	8h	10h	20h	100h
1.60V	64.4	41.1	30.2	27.7	17.6	12.4	8.4	5.5	5.0	2.7	0.60
1.67V	63.2	40.4	29.7	27.2	17.3	12.2	8.3	5.5	4.9	2.6	0.59
1.70V	62.1	39.6	29.1	26.7	17.0	11.9	8.1	5.4	4.8	2.6	0.58
1.75V	60.9	38.9	28.6	26.2	16.7	11.7	8.0	5.3	4.7	2.6	0.57
1.80V	58.6	37.4	27.5	25.2	16.0	11.3	7.7	5.0	4.5	2.5	0.56

Note The above data are average values, and can be obtained within 3 charge/discharge cycles. These are not minimum values. Cell and battery designs/specifications are subject to modification without notice. Contact **CBB** for the latest information.

PERFORMANCE CHARACTERISTICS

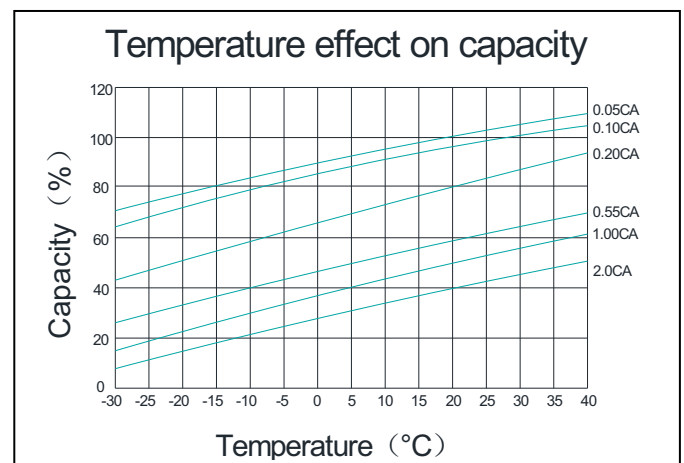
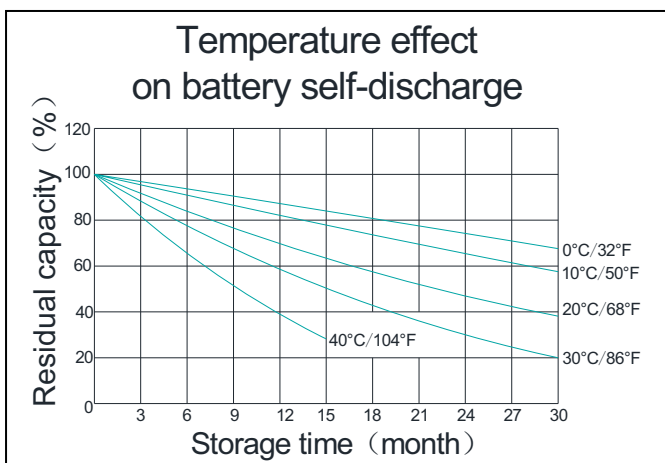
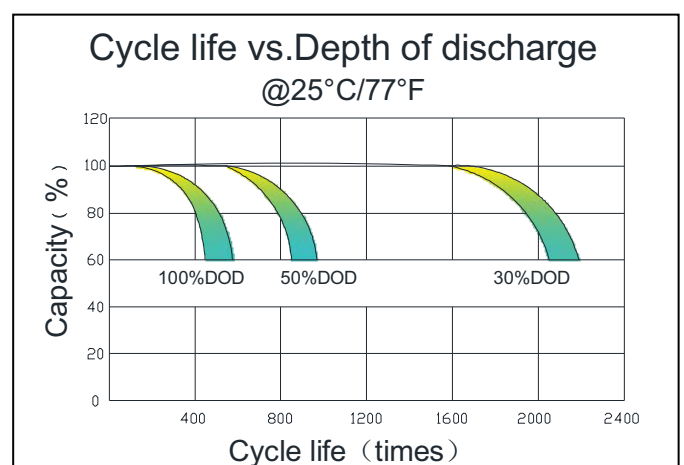
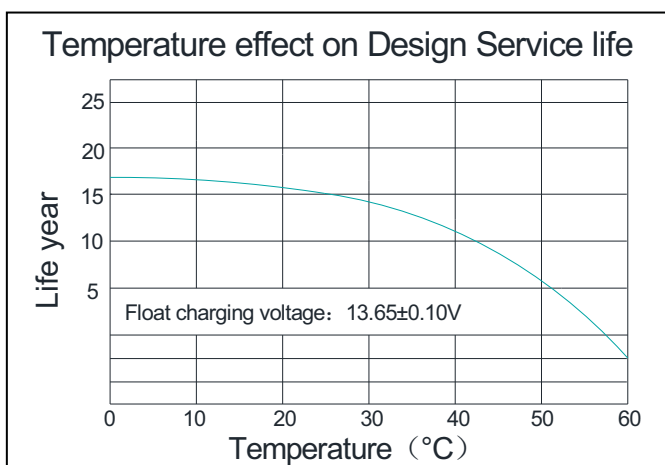
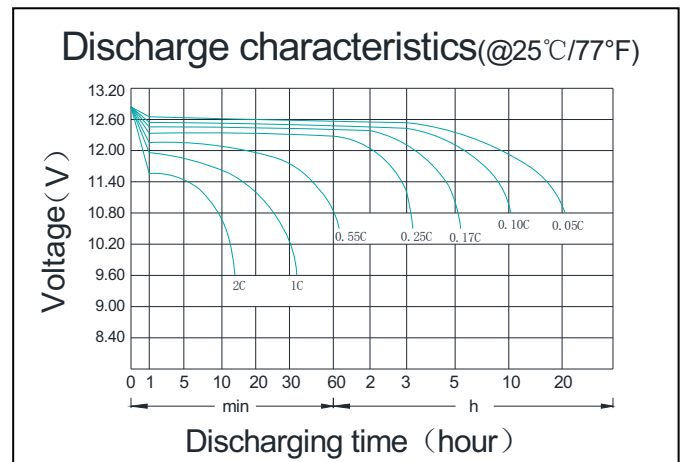
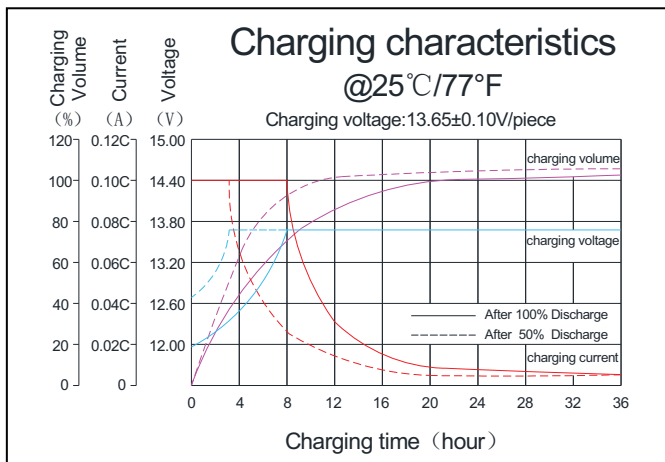

BATTERY CONSTRUCTION

Component	Positive plate	Negative plate	Container & Cover	Safety valve	Terminal	Separator	Electrolyte	Pillar seal
Features	Thick high Sn low Ca grid with special paste	Balanced Pb-Ca grid for improved recombination efficiency	ABS (UL94-V0 optional)	Flame Si-Rubbeand aging resistanacer	Female Copper Insert M6(torque:4 ~6N.m)	Advanced AGM separator for high pressure cell design	Dilute high purity sulphuric acid with fumed Silica gel	Two layers epoxy resin seal