

GENERAL FEATURES

- Optimized plate achieve low IR
- 30% increased power output at 15 min
- Deep Discharge Recovery
- High Power Density
- Wide operating temperature

APPLICATIONS

- UPS & EPS
- Emergency lighting Systems
- Medical Equipment
- The office computer
- Cable TV Systems
- Alarm Systems



DIMENSIONS & WEIGHT

Length(mm)	522±1
Width(mm)	240±1
Height(mm)	219±1
Total Height(mm)	223±1
Weight(kg)	69±3%

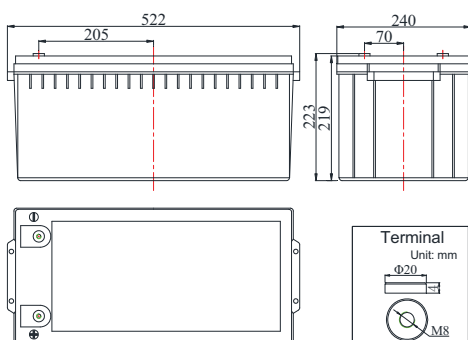

COMPLIED STANDARDS

IEC 60896-21/22	JIS C8704
YD/T799	BS6290 part4
GB/T 19638	UL 1989

TECHNICAL SPECIFICATIONS



Nominal Voltage		12V(6 cells per unit)
Design Floating Life @25°C		12 Years
Watts/cell@25°C(@15min,10.02V)		770W
Capacity @25°C	10 hour rate (22.0A,10.8V)	220Ah
	3 hour rate (64.1A,10.5V)	192.3Ah
	1 hour rate (167.1A,9.6V)	167.1Ah
Internal Resistance	Full Charged Battery@25°C	≤3.1mΩ
Ambient Temperature	Discharge	-20°C~50°C
	Charge	-20°C~50°C
	Storage	-20°C~50°C
Max.Discharge Current@25°C		3300A(5s)
Capacity affected by Temperature (10 hr Capacity)	40°C	102%
	25°C	100%
	0°C	85%
	-15°C	65%
Self-Discharge@25°C per Month		3%
Charge (Constant Voltage) @25°C	Standby Use	Initial Charging Current Less than 55.0A Voltage 13.6-13.8V
	Cycle Use	Initial Charging Current Less than 55.0A Voltage 14.4-14.9V

BATTERY DISCHARGE TABLE

Discharge Constant Power per Cell (Watts at 25°C)

F.V/Time	10min	15min	20min	25min	30min	45min	60min	90min	120min	180min	600min
1.60V	1016.2	783.3	649.1	551.8	491.8	370.6	303.4	214.8	168.5	116.0	43.7
1.67V	997.9	770.0	640.9	541.3	482.6	363.7	297.7	211.0	165.5	115.0	43.1
1.70V	979.3	755.4	629.2	531.5	473.7	357.0	291.9	206.6	162.0	114.5	42.7
1.75V	961.0	741.0	609.3	521.7	465.1	350.4	286.8	202.8	160.0	113.4	41.9
1.80V	940.8	720.0	585.8	508.4	449.5	337.0	273.5	196.6	157.8	111.9	41.5

Discharge Constant Current per Cell (Amperes at 25°C)

F.V/Time	10min	15min	20min	25min	30min	45min	60min	90min	120min	180min	600min
1.60V	614.8	472.1	392.0	341.2	288.8	213.8	167.1	120.6	96.1	67.7	23.9
1.67V	603.7	463.5	387.3	335.0	283.3	209.9	165.5	118.4	94.4	66.6	23.4
1.70V	592.2	455.1	380.1	328.8	278.0	206.1	162.9	116.0	92.5	65.2	23.1
1.75V	581.1	446.5	368.0	322.6	272.8	202.2	160.4	113.9	90.8	64.1	22.6
1.80V	571.8	437.8	357.7	310.2	267.5	200.0	157.5	110.7	88.2	62.2	22.0

Note The above data are average values, and can be obtained within 3 charge/discharge cycles. These are not minimum values. Cell and battery designs/specifications are subject to modification without notice. Contact **CBB** for the latest information.

PERFORMANCE CHARACTERISTICS

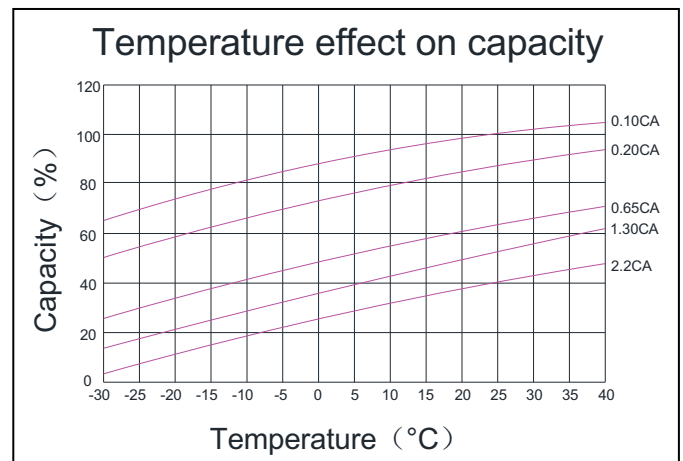
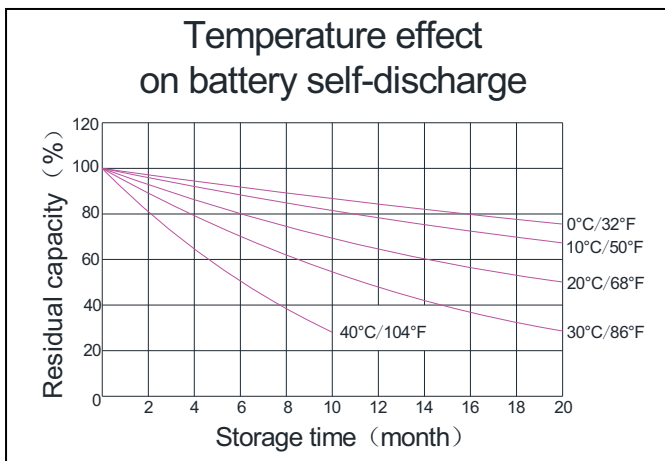
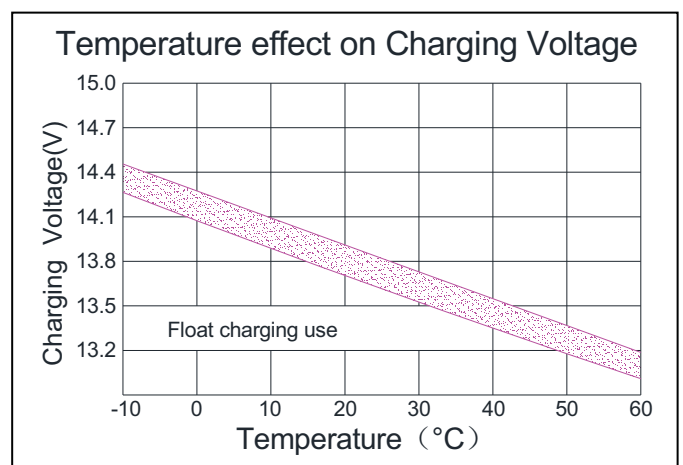
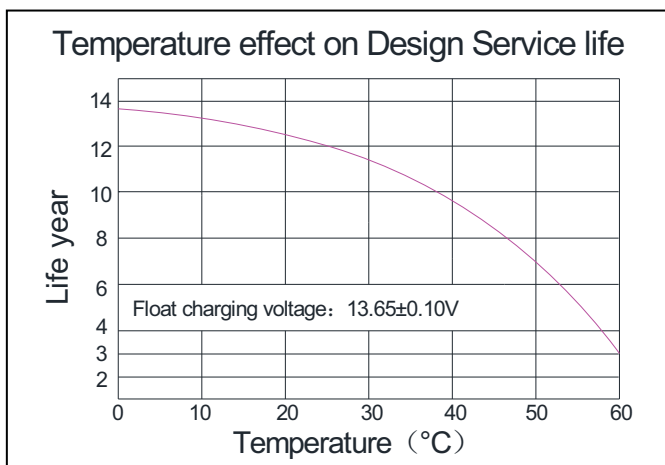
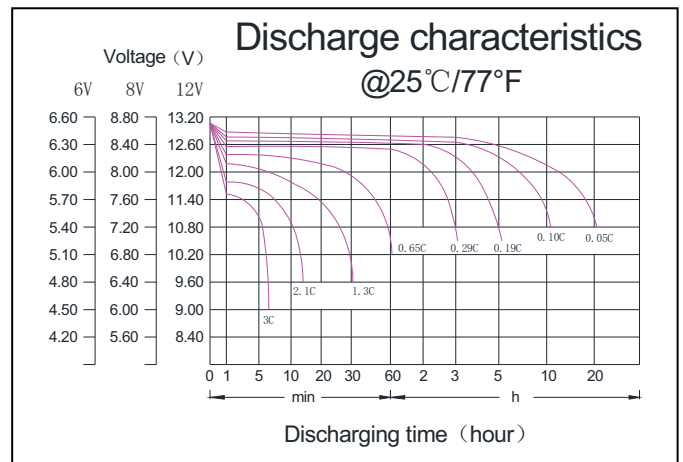
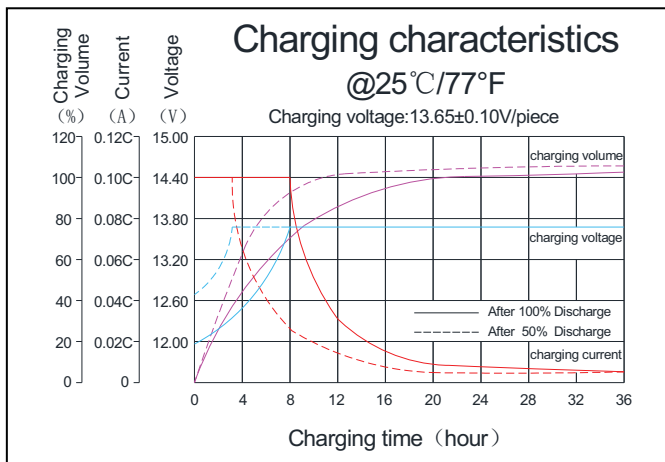

BATTERY CONSTRUCTION

Component	Positive plate	Negative plate	Container & Cover	Safety valve	Terminal	Separator	Electrolyte	Pillar seal
Features	Thick high Sn low Ca grid with special paste	Balanced Pb-Ca grid for improved recombination efficiency	ABS (UL94-V0 optional)	Flame Si-Rubbeand aging resistancer	Female Copper Insert M8(torque:1 2~14N.m	Advanced AGM separator for high pressure cell design	Dilute high purity sulphuric acid	Two layers epoxy resin seal

CBB Battery Technology Co.,Ltd.

RM504,55 Hanxing Zhong Road,Zhongcun, Panyu,Guangzhou 511495 China
 Tel: +86-020-84888946 Fax: +86-020-62824569

Koyama®

www.cbb-battery.com