

GENERAL FEATURES

- Environmentally friendly
- Can be used at vertical or horizontal orientation
- High Reliability and Good Quality
- High gas recombination efficiency
- High Power Density
- Maintenance-Free Operation

APPLICATIONS

- UPS & EPS
- Emergency lighting Systems
- Medical Equipment
- Cable TV Systems
- Alarm Systems
- Electric Test Equipment
- Security Systems



DIMENSIONS & WEIGHT

Length(mm)	165±1
Width(mm)	126±1
Height(mm)	174±1
Total Height(mm)	174±1
Weight(kg)	7.7±3%

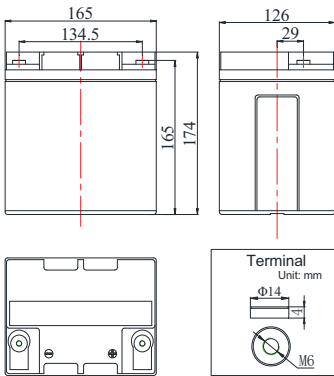

COMPLIED STANDARDS

IEC 60896-21/22	JIS C8704
YD/T799	BS6290 part4
GB/T 19638	UL 1989

TECHNICAL SPECIFICATIONS



Nominal Voltage		12V(6 cells per unit)
Design Floating Life @25°C		10 Years
Nominal Capacity @25°C(10 hour rate@2.40A,10.80V)		24Ah
Capacity @25°C	20 hour rate (1.28A,10.5V)	25.6Ah
	5 hour rate (4.2A,10.5V)	21.0Ah
	1 hour rate (15.3A,9.6V)	15.3Ah
Internal Resistance	Full Charged Battery@25°C	≤14mΩ
Ambient Temperature	Discharge	-20°C~50°C
	Charge	-20°C~50°C
	Storage	-20°C~50°C
Max.Discharge Current@25°C		240A(5s)
Capacity affected by Temperature (10 hr Capacity)	40°C	102%
	25°C	100%
	0°C	85%
	-15°C	65%
Self-Discharge@25°C per Month		3%
Charge (Constant Voltage) @25°C	Standby Use	Initial Charging Current Less than 6.0A Voltage 13.6-13.8V
	Cycle Use	Initial Charging Current Less than 6.0A Voltage 14.4-14.9V

BATTERY DISCHARGE TABEL

Discharge Constant Current per Cell (Amperes at 25°C)

F.V/Time	15min	30min	45min	1h	2h	3h	5h	6h	8h	10h	20h
1.60V	43.3	25.5	19.3	15.3	9.0	6.6	4.5	3.9	3.0	2.5	1.33
1.67V	40.9	24.2	18.6	14.9	8.7	6.4	4.4	3.8	3.0	2.5	1.32
1.70V	38.4	23.5	17.9	14.3	8.5	6.2	4.3	3.7	3.0	2.4	1.30
1.75V	36.0	22.4	17.1	13.7	8.3	6.1	4.2	3.7	2.9	2.4	1.28
1.80V	33.8	21.6	16.5	13.2	7.9	5.9	4.1	3.6	2.9	2.4	1.27

Discharge Constant Power per Cell (Watts at 25°C)

F.V/Time	15min	30min	45min	1h	2h	3h	5h	6h	8h	10h	20h
1.60V	82.8	50.7	36.7	29.4	17.1	12.6	8.6	7.5	6.0	4.9	2.6
1.67V	79.2	47.5	35.4	28.6	16.6	12.3	8.5	7.4	5.9	4.9	2.6
1.70V	73.8	46.5	34.3	27.6	16.2	12.0	8.4	7.3	5.8	4.8	2.6
1.75V	69.3	44.2	33.0	26.6	15.8	11.8	8.2	7.2	5.8	4.8	2.6
1.80V	65.0	42.4	31.8	25.7	15.3	11.4	8.1	7.1	5.7	4.8	2.5

Note The above data are average values, and can be obtained within 3 charge/discharge cycles. These are not minimum values. Cell and battery designs/specifications are subject to modification without notice. Contact **CBB** for the latest information.

PERFORMANCE CHARACTERISTICS

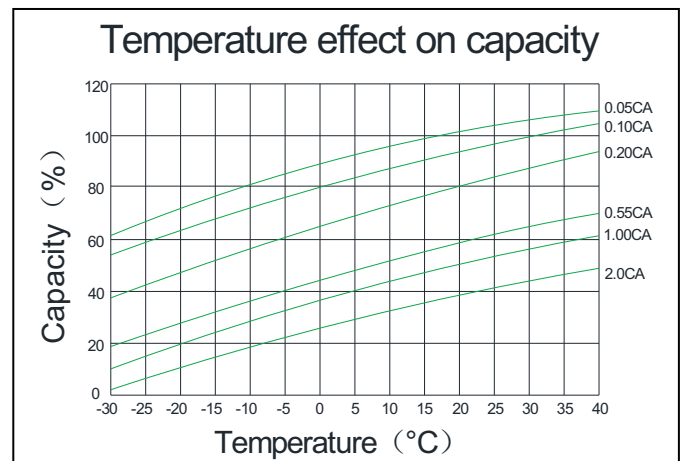
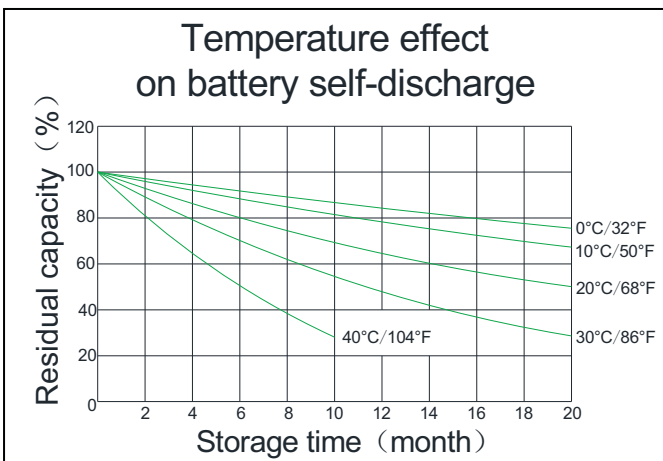
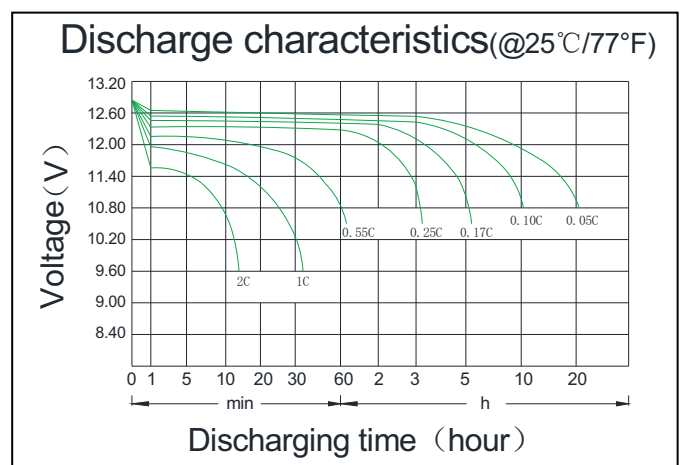
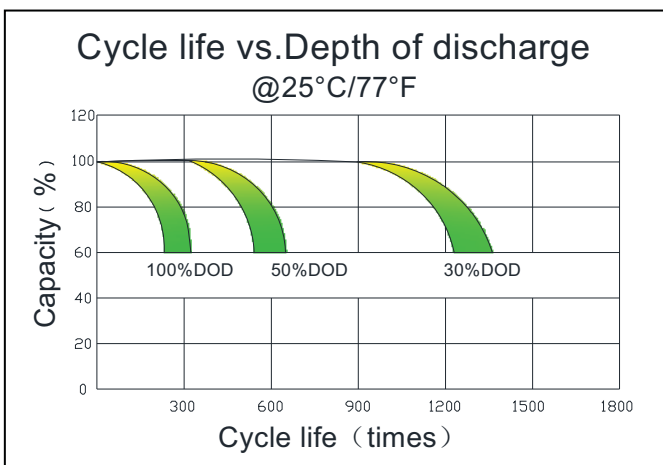
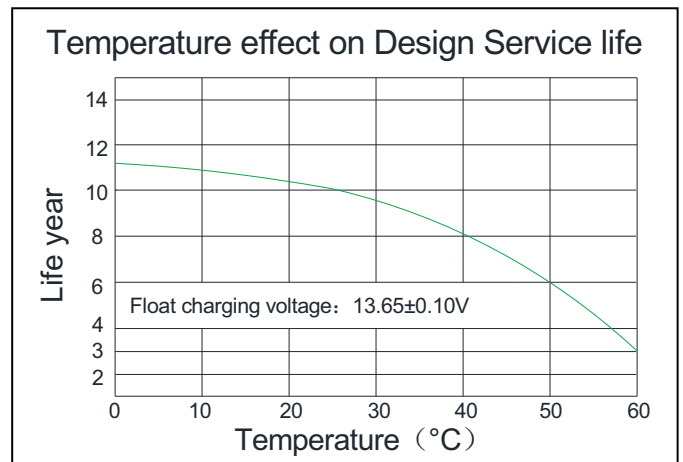
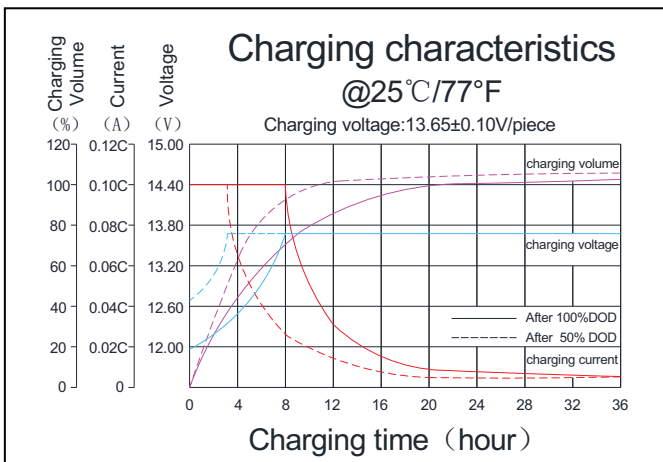

BATTERY CONSTRUCTION

Component	Positive plate	Negative plate	Container & Cover	Safety valve	Terminal	Separator	Electrolyte	Pillar seal
Features	Thick high Sn low Ca grid with special paste	Balanced Pb-Ca grid for improved recombination efficiency	ABS (UL94-V0 optional)	Flame Si-Rubber and aging resister	Female Copper Insert M6 (torque: 3~4N.m)	Advanced AGM separator for high pressure cell design	Dilute high purity sulphuric acid	Two layers epoxy resin seal

CBB Battery Technology Co., Ltd.

RM504,55 Hanxing Zhong Road, Zhongcun, Panyu, Guangzhou 511495 China
 Tel: +86-020-84888946 Fax: +86-020-62824569

Koyama®

www.cbb-battery.com