



GENERAL FEATURES

- Thick plate with high Tin low Calcium alloy
- High Reliability and Good Quality
- High gas recombination efficiency
- High Power Density
- Long Service Life, in Float or Cyclic

APPLICATIONS

- Solar Systems
- Power station
- Telecom systems
- Cable TV Systems
- UPS & EPS
- Renewable energy system

DIMENSIONS & WEIGHT

Length(mm)	241±1
Width(mm)	171±1
Height(mm)	329±1
Total Height(mm)	365±1
Weight(kg)	31.0±3%

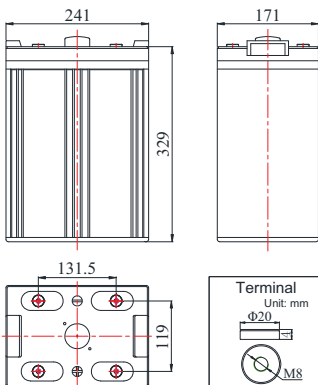

COMPLIED STANDARDS

IEC 60896-21/22	JIS C8704
YD/T799	BS6290 part4
GB/T 19638	UL 1989

TECHNICAL SPECIFICATIONS



Nominal Voltage		2V(1 cells per unit)
Design Floating Life @25°C		15 Years
Nominal Capacity @25°C (10 hour rate@50.0A,1.8V)		500Ah
Capacity @25°C	20 hour rate (26.5A,1.8V)	530Ah
	5 hour rate (88.0A,1.75V)	440Ah
	1 hour rate (320.5A,1.6V)	320.5Ah
Internal Resistance	Full Charged Battery@25°C	≤0.53mΩ
Ambient Temperature	Discharge	-20°C~50°C
	Charge	-20°C~50°C
	Storage	-20°C~50°C
Max.Discharge Current@25°C		2500A(5s)
Capacity affected by Temperature (10 hr Capacity)	40°C	105%
	25°C	100%
	0°C	85%
	-15°C	65%
Self-Discharge@25°C per Month		3%
Charge (Constant Voltage) @25°C	Standby Use	Initial Charging Current Less than 75A Voltage 2.23-2.27V
	Cycle Use	Initial Charging Current Less than 75A Voltage 2.33-2.37V

BATTERY DISCHARGE TABEL

Discharge Constant Current per Cell (Amperes at 25°C)

F.V/Time	30min	45min	1h	2h	3h	4h	5h	6h	8h	10h	20h
1.60V	531.5	402.5	320.5	187.5	143.0	111.0	93.0	81.0	65.0	52.5	27.75
1.65V	503.5	387.0	310.0	181.5	138.5	108.5	91.5	79.5	64.5	51.5	27.50
1.70V	489.0	373.0	301.5	176.5	135.0	106.0	89.5	78.0	63.5	51.0	27.20
1.75V	467.5	356.5	290.5	172.0	132.0	103.5	88.0	76.5	63.0	50.5	26.95
1.80V	450.5	343.5	280.5	165.5	128.0	101.0	86.0	75.0	61.0	50.0	26.50

Discharge Constant Power per Cell (Watts at 25°C)

F.V/Time	30min	45min	1h	2h	3h	4h	5h	6h	8h	10h	20h
1.60V	1025.5	764.5	617.0	355.5	273.5	213.0	179.5	156.5	128.0	102.5	54.5
1.65V	979.5	738.5	600.5	346.0	266.5	209.0	176.5	154.0	127.0	101.5	53.5
1.70V	938.0	715.0	580.0	338.0	260.5	205.0	174.0	152.0	125.0	100.5	53.0
1.75V	891.5	686.5	559.0	330.0	255.5	200.5	171.5	149.5	122.0	99.5	52.5
1.80V	854.0	663.5	541.0	319.0	248.5	196.0	168.0	147.0	119.5	99.0	52.0

Note The above data are average values, and can be obtained within 3 charge/discharge cycles. These are not minimum values. Cell and battery designs/specifications are subject to modification without notice. Contact **CBB** for the latest information.

PERFORMANCE CHARACTERISTICS

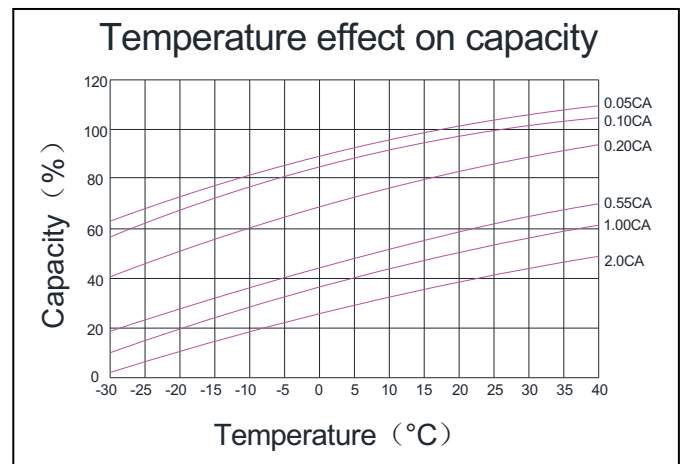
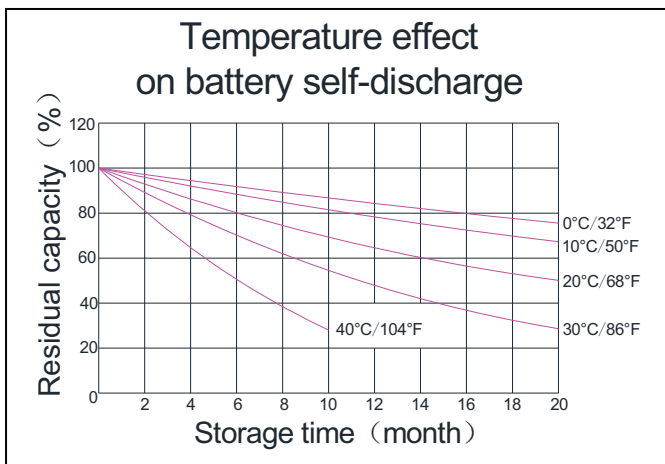
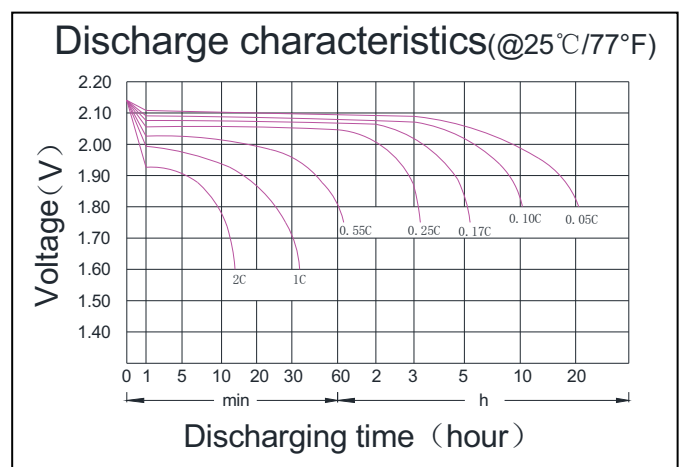
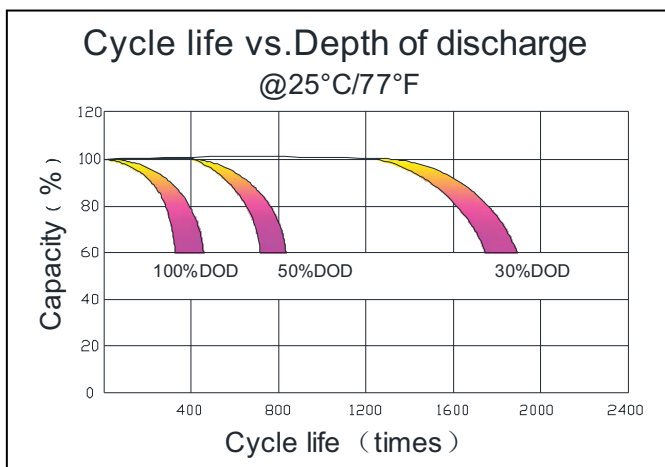
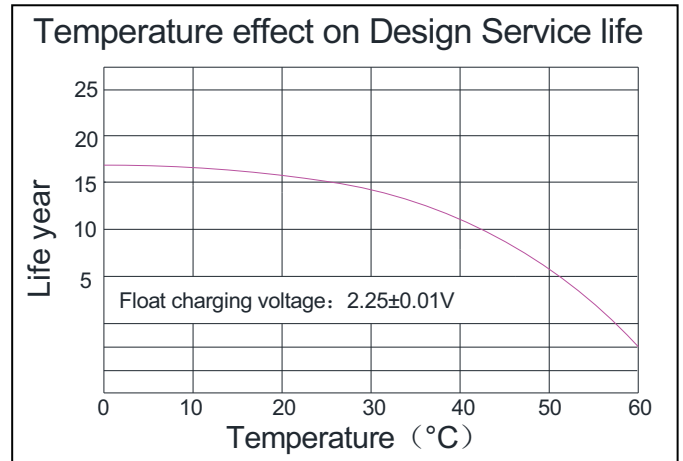
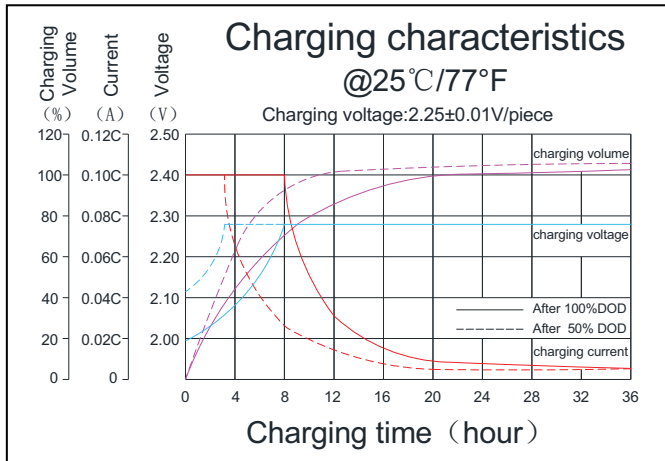

BATTERY CONSTRUCTION

Component	Positive plate	Negative plate	Container & Cover	Safety valve	Terminal	Separator	Electrolyte	Pillar seal
Features	Thick high Sn low Ca grid with special paste	Balanced Pb-Ca grid for improved recombination efficiency	ABS (UL94-V0 optional)	Flame Si-Rubber and aging resister	Female Copper Insert M8 (torque: 10~12N.m)	Advanced AGM separator for high pressure cell design	Dilute high purity sulphuric acid	Two layers epoxy resin seal

CBB Battery Technology Co., Ltd.

RM504,55 Hanxing Zhong Road, Zhongcun, Panyu, Guangzhou 511495 China
 Tel: +86-020-84888946 Fax: +86-020-62824569

Koyama®

www.cbb-battery.com