

SGD-M-50W

Shingles PERC technology Solar Panel

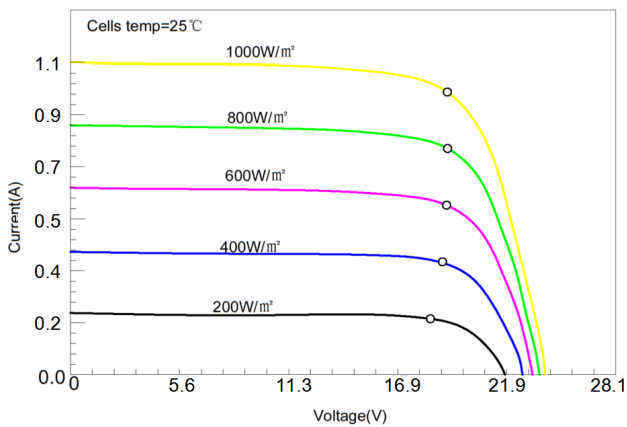

Module Diagram

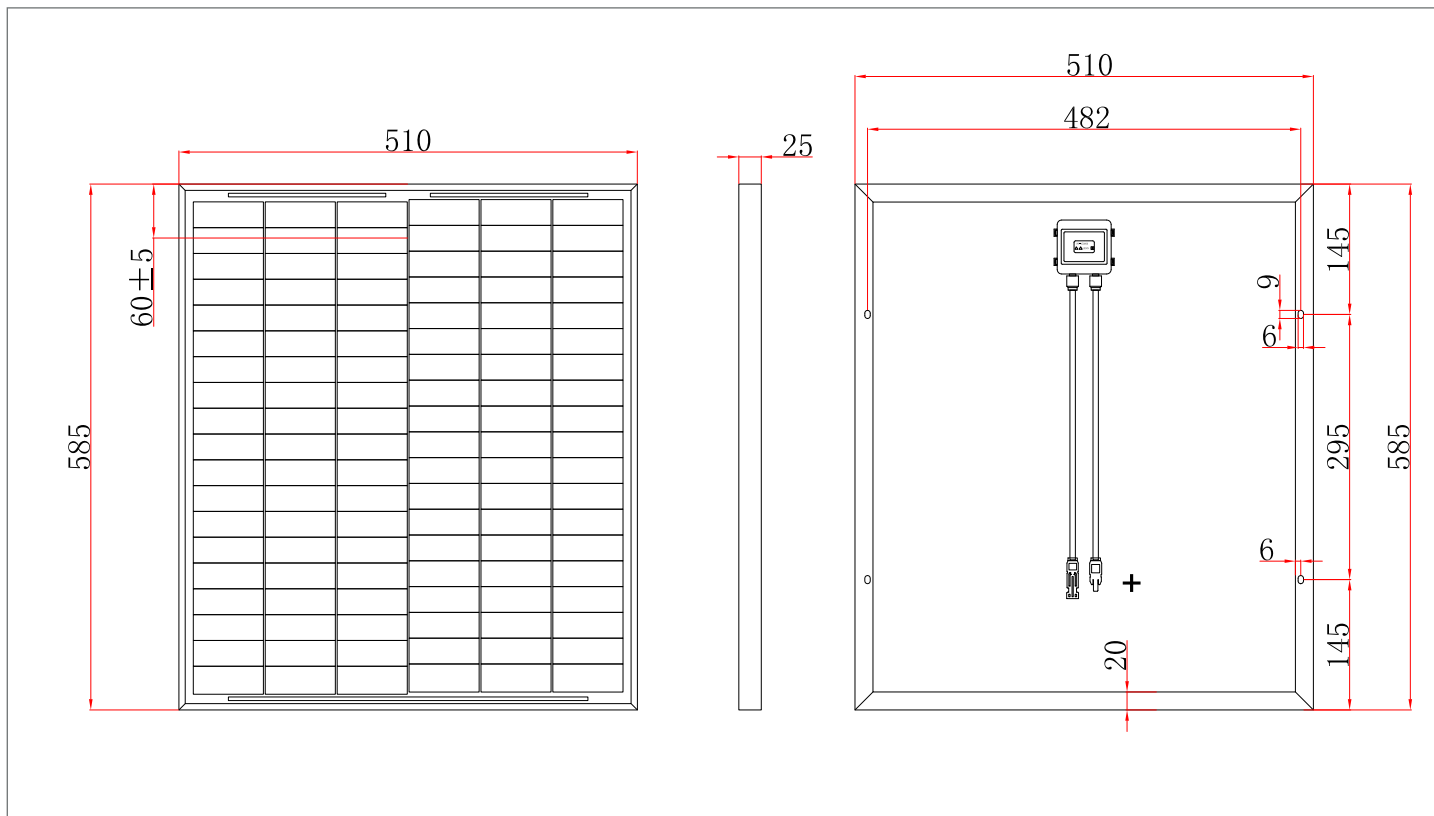

Electrical Characteristics

Maximum power(Pmax)	50W
Open-circuit voltage(Voc)	23.2
Voltage at Pmax(Vmp)	19.7
Short-circuit current(Isc)	2.69
Current at Pmax(Imp)	2.54
Cells Efficiency(%)	21.24%
The maximum system voltage	1000VDC(IEC)
Power temperature coefficient	-0.43%/°C
Voltage temperature coefficient	-0.34%/°C
Current temperature coefficient	0.05%/°C
Output power tolerance	±3%
Operating Temperature	-40~85°C



— Product details —

Specifications

Solar cell brand	Mono
No.of cells and connections	114(6*19)
Module dimension	585*510*25mm
Weight	3.28KG
Waterproof junction box	IP65/IP67
Warranty	10 year and service life 25 years