



for

LED



eLED

eLED-OSR-9580 Osram Modular Passive Star LED Heat Sink ϕ 95mm

Features VS Benefits

- * The eLED-OSR-9580 OSRAM Modular Passive LED Coolers are specifically designed for luminaires using the OSRAM LED engines.
- * Mechanical compatibility with direct mounting of the LED engines to the LED cooler and thermal performance matching the lumen packages.
- * For spotlight and downlight designs from 2100 to 5500 lumen.
- * Thermal resistance range Rth 1.1°C/W.
- * Modular design with mounting holes foreseen for direct mounting SOLERIQ P , SOLERIQ E and SOLERIQ S LED engines.
- of OSRAM PrevaLED Core ,
- * Diameter 95mm - standard height 80mm Other heights on request.
- * Extruded from highly conductive aluminum.

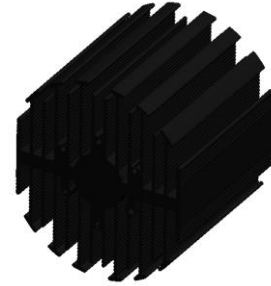

Zhaga LED engine and radiator assembly is a unified future international standardization

- * Below you find an overview of OSRAM engines COB's and LED modules which standard fit on the eLED coolers.
- * In this way mechanical after work and related costs can be avoided, and lighting designers can standardize their designs on a limited number of LED coolers.

OSRAM



BJB



IDEAL

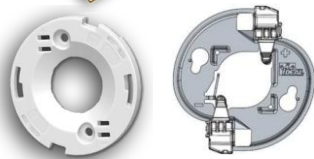

OSRAM LED engines Mounting Options

Osram PrevaLED Core AC LED modules.

- PL-CORE AC PRO -3000-830;
- PL-CORE AC PRO -3000-840;

Osram PrevaLED Core Z3 LED modules.

- PL-CORE -3000-830-Z3;
- PL-CORE -3000-840-Z3;
- PL-CORE -3000-930-Z3;
- PL-CORE -5000-830-Z3;
- PL-CORE -5000-840-Z3;

Osram PrevaLED Core Z4 LED modules.

- PL-CORE-Z4 -3000-930;
- PL-CORE-Z4 -4500-930;
- PL-CORE-Z4 -5000-830;
- PL-CORE-Z4 -5000-835;
- PL-CORE-Z4 -5000-840;

Zhaga Book3

Green indicator marks:

Direct mounting with machine screws M3x6mm;

Osram SOLERIQ P13 modules.

- GW MAGMB1.CM-SUTR-27S3;
- GW MAGMB1.CM-TPTS-30S3;
- GW MAGMB1.CM-TPTS-35S3;
- GW MAGMB1.CM-TQTT-40S3;

- GW MAGMB1.EM-TQTT-27S3;
- GW MAGMB1.EM-TRTU-30S3;
- GW MAGMB1.EM-TSUP-35S3;
- GW MAGMB1.EM-TSUP-40S3;
- GW MAGMB1.EM-TSUP-50S3;

Zhaga Book3 Green indicator marks:

BJB holder:47.319.2131.50 ;

IDEAL holder:50-2101CR ;

Direct mounting with machine screws M3x6mm;

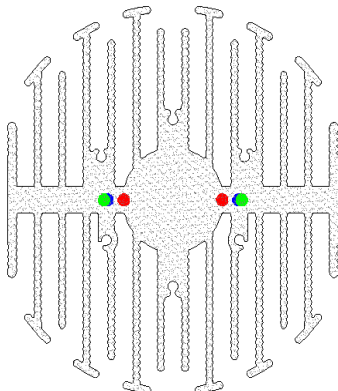

Tel:+86-769-33252828 +86-769-33251919

E-fax:+86-(020)28819702 ext:22122

Email:sales@mingfatech.com

Http://www.heatsinkled.com

Http://www.mingfatech.com





for

LED



eLED

eLED-OSR-9580 Osram Modular Passive Star LED Heat Sink Φ 95mm



STUCCHI
Ideas are made of light

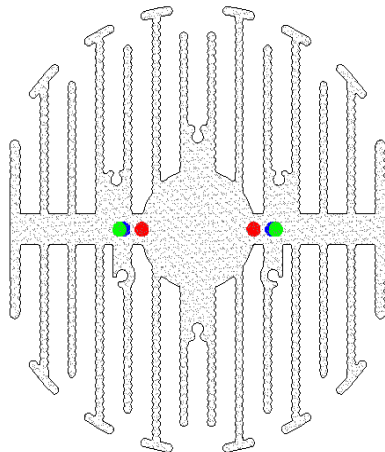

Osram SOLERIQ S19 LED modules:

GW KAHJB1.EM-SSSU-27S3;
GW KAHJB1.EM-SSSU-30S3;
GW KAHJB1.EM-STTP-35S3;
GW KAHJB1.EM-STTP-40S3;

GW KAHLB1.EM-TQTS-27S3;
GW KAHLB1.EM-TQTT-30S3;
GW KAHLB1.EM-TRTT-35S3;
GW KAHLB1.EM-TRTU-40S3;

GW KAHNB1.CM-TSTU-27S3;
GW KAHNB1.CM-TSTU-30S3;
GW KAHNB1.CM-TTUP-35S3;
GW KAHNB1.CM-TUQU-40S3;

GW KAHJB1.EM-SQSS-27S3;
GW KAHJB1.EM-SQSS-30S3;
GW KAHJB1.EM-SRST-35S3;
GW KAHJB1.EM-SRST-40S3;

GW KAHLB1.EM-SUTQ-27S3;
GW KAHLB1.EM-TPTR-30S3;
GW KAHLB1.EM-TPTR-35S3;
GW KAHLB1.EM-TQTS-40S3;

GW KAHNB1.EM-TUQU-27S3;
GW KAHNB1.EM-TUUR-30S3;
GW KAHNB1.EM-UPUR-35S3;
GW KAHNB1.EM-UPUS-40S3;

Zhaga Book3

Green indicator marks:

BJB holder:47.319.2170.50 ;

AAG.STUCCHI holder:8503-G2

Direct mounting with machine screws M3x6mm.

Osram SOLERIQ P9 modules.

GW MAFJB1.EM-RTSQ-27S3;
GW MAFJB1.EM-RUSR-30S3;
GW MAFJB1.EM-RUSS-35S3;
GW MAFJB1.EM-SPST-40S3;
GW MAFJB1.EM-SPST-50S3;

GW MAFJB1.CM-RSSP-27S3;
GW MAFJB1.CM-RTSQ-30S3;
GW MAFJB1.CM-RTSR-35S3;
GW MAFJB1.CM-RUSS-40S3;

Zhaga Book11 Red indicator marks:

BJB holder:47.319.6200.50 ;

AAG.STUCCHI holder:8501-G2

Direct mounting with machine screws M3x6mm;

OSRAM LED engines directly Mounting Options

Osram SOLERIQ E30 LED modules.

GW KAJRB2.EM-STTQ-27H4;
GW KAJRB2.EM-SUTQ-30H4;
GW KAJRB2.EM-TPTR-40H4;
GW KAJRB2.EM-TPTR-50H4;
GW KAJRB2.EM-TPTR-57H4;
GW KAJRB2.EM-TPTR-65H4;

Direct mounting with machine screws M3x6mm;
Blue indicator marks.



Mingfa *for* LED

eLED

eLED-OSR-9580 Osram Modular Passive Star LED Heat Sink Φ 95mm

Mounting Options and Drawings & Dimensions

Example:eLED-OSR-9580-B-3

Example:eLED-OSR-95 **1** - **2** - **3**

- 1** Height (mm)
- 2** Anodising Color
B-Black
C-Clear
Z-Custom
- 3** Mounting Options - see graphics for details Combinations available
Ex.order code - 12
means option 1 and 2 combined



Notes:

- Mentioned models are an extraction of full product range.
- For specific mechanical adaptations please contact MingfaTech.
- MingfaTech reserves the right to change products or specifications without prior notice.

Note : option 2 and option 3 can not be combined

MOUNTING OPTION	Module type	Holder NO.	THREAD	THREAD DEPTH	THREAD HOLE DISTANCE
1	SOLERIQ P9	AAG.STUCCHI:8501-G2	M3	6.5mm	25.0mm/ 2-@180°
		BJB:47.319.6200.50			
2	SOLERIQ E30	/	M3	6.5mm	33.3mm/ 2-@180°
3	PrevaLED Core AC PrevaLED Core Z3 PrevaLED Core Z4	/	M3	6.5mm	35.0mm/ 2-@180°
	SOLERIQ S19	AAG.STUCCHI:8503-G2			
		BJB:47.319.2170.50			
	SOLERIQ p13	IDEAL:50-2101CR			
BJB:47.319.2131.50					

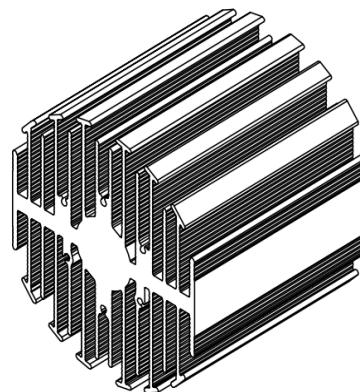
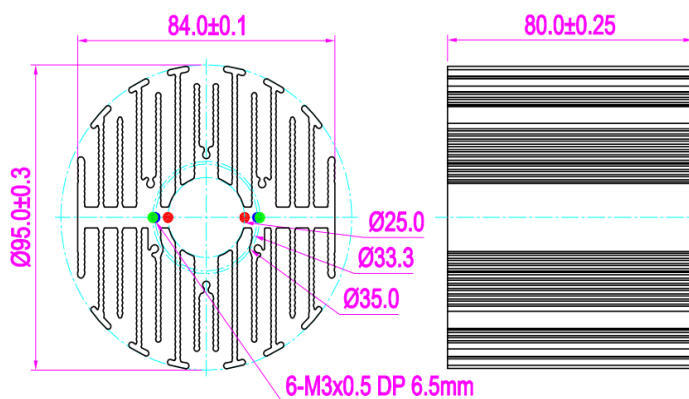

Tel:+86-769-33252828 +86-769-33251919
E-fax:+86-(020)28819702 ext:22122
Email:sales@mingfatech.com
Http://www.heatsinkled.com
Http://www.mingfatech.com





for

LED



eLED

eLED-OSR-9580 Osram Modular Passive Star LED Heat Sink Φ 95mm

The thermal data table

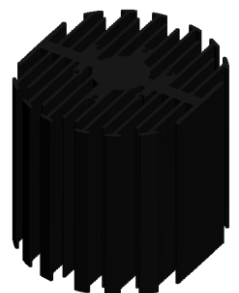
	 <i>eLED-9580</i>
Model No.	eLED-OSR-9580
Size	Φ95xH80mm
Material	AL6063-T5
Finish	Black Anodized
Weight(gr)	564
Thermal Wattage	49.2W
HeatsinkOs-a²	170178
Heat Sink T Rise Above Ambient	1.1

Dissipated Power Pd(W)	Pd = Pe x (1-ηL)	Heat sink to ambient thermal resistance Rhs-amb (°C/W)	Heat sink to ambient temperature rise Ths-amb (°C)
		eLED-OSR-9580	
10		1.6	16
20		1.3	26
30		1.2	35
40		1.1	44
50		1.0	52

