



for

LED



xLED

xLED-LUN-7050 Pin Fin LED Heat Sink Φ 70mm for Luminus

Features VS Benefits

- * The xLED-LUN-7050 Luminus Pin Fin LED Heat Sinks are specifically designed for luminaires using the Luminus LED engines.
- * Mechanical compatibility with direct mounting of the LED engines to the LED cooler and thermal performance matching the lumen packages.
- * For spotlight and downlight designs from 1,000 to 2,600 lumen.
- * Thermal resistance range Rth 3.13°C/W.
- * Modular design with mounting holes foreseen for direct mounting of Luminus COB series.
- * Diameter 70mm - standard height 50mm, Other heights on request.
- * Forged from highly conductive aluminum.



Zhaga LED engine and radiator assembly is a unified future international standardization

- * Below you find an overview of Luminus COB's and LED modules which standard fit on the Pin Fin LED Heat Sinks.
- * In this way mechanical after work and related costs can be avoided, and lighting designers can standardize their designs on a limited number of LED Pin Fin LED Heat Sink.

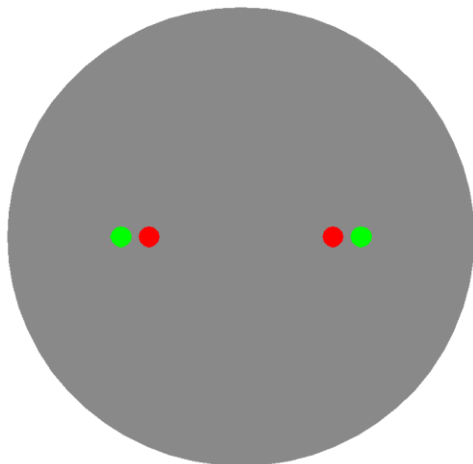
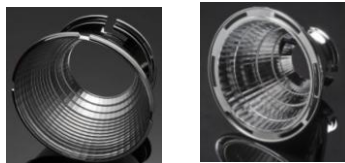
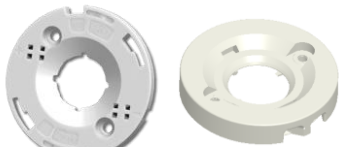

Luminus LED Modules directly Mounting Options

Luminus COB series.

- CXM-11-AC;
- CIM/CLM/CXM-14;

With the Zhaga Book 3 holders for the green indicator marks.

TE Connectivity Holder: 2213254-1;

BJB Holder:47.319.2021.50;

Without the holders for the red indicator marks.

Direct mounting with machine screws M3x6.5mm.

With the LEDiL products:

Lena series: CN12xxx;

Lenina series: CN12xxx; C12xxx;

Luminus COB series.

- CXM-18;

With the Zhaga Book 3 holders for the green indicator marks.

TE Connectivity Holder: 2213258-1;

BJB Holder:47.319.2280.50;

Direct mounting with machine screws M3x6.5mm.

With the LEDiL products:

Lena series: CN12xxx;

xLED

xLED-LUN-7050 Pin Fin LED Heat Sink Φ 70mm for Luminus

Mounting Options and Drawings & Dimensions

Example: xLED-LUN-7050-B-1,2

Example: xLED-LUN-70 **1** - **2** - **3**

- 1** Height (mm)
- 2** Anodising Color
 - B-Black
 - C-Clear
 - Z-Custom
- 3** Mounting Options - see graphics for details Combinations available
Ex.order code - 12
means option 1 and 2 combined

Notes:

- Mentioned models are an extraction of full product range.
- For specific mechanical adaptations please contact MingfaTech.
- MingfaTech reserves the right to change products or specifications without prior notice.

MOUNTING OPTION	Module type	Holder NO.	LEDiL products		THREAD	THREAD DEPTH	THREAD HOLE DISTANCE
			Lenina Series	Lena series			
1		/			M3	6.5mm	26.8mm/ 2-@180°
2	CXM-11; CIM/CLM/CXM-14	BJB Holder 47.319.2021.50	CN12xxx; C12xxx;	CN12xxx;	M3	6.5mm	35.0mm/ 2-@180° (Zhaga book 3)
		TE Holder 2213254-1					
	CXM-18;	BJB Holder 47.319.2280.50	/				
		TE Holder 2213258-1					

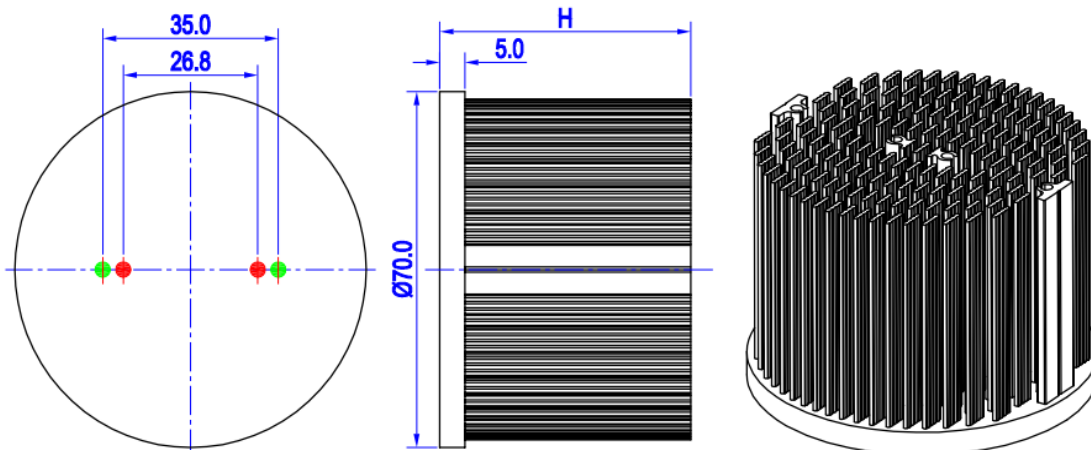

xLED

xLED-LUN-7050 Pin Fin LED Heat Sink Φ 70mm for Luminus

The product data table

	Model No.	xLED-LUN-7050
	Heatsink Size	Φ 70xH50mm
	Heatsink Material	AL1070
	Finish	Black Anodized
	Weight (g)	150.0
	Dissipated power (T _{hs-amb} ,50°C)	16.0 (W)
	Cooling surface area (mm ²)	91577
	Thermal Resistance (R _{hs-amb})	3.13 (°C/W)

The thermal data table

* Please be aware the dissipated power Pd is not the same as the electrical power Pe of a LED module.

*To calculate the dissipated power please use the following formula: Pd = Pe x (1-ηL).

Pd - Dissipated power ; Pe - Electrical power ; ηL = Light efficiency of the LED module;

Dissipated Power Pd(W)	Pd = Pe x (1-ηL)	Heat sink to ambient thermal resistance R _{hs-amb} (°C/W)	Heat sink to ambient temperature rise T _{hs-amb} (°C)
		xLED-LUN-7050	
4.0		4.25	17.0
8.0		3.63	29.0
12.0		3.33	40.0
16.0		3.13	50.0
20.0		2.95	59.0

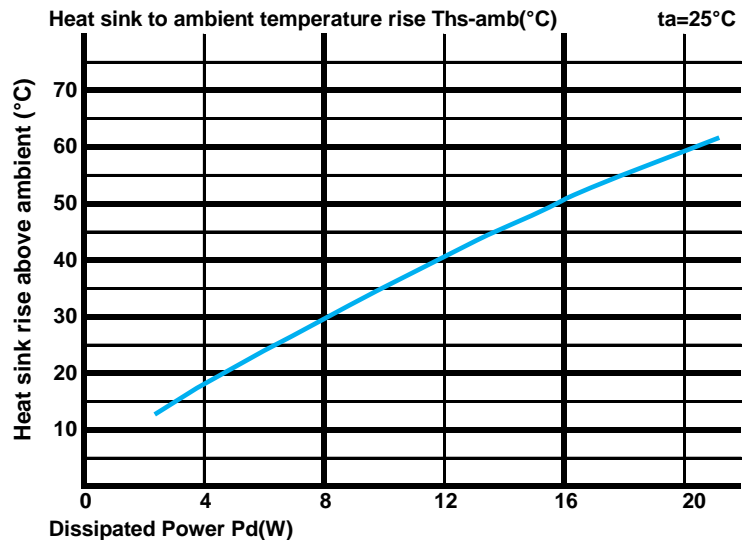

*The aluminum substrate side of the package outer shell is thermally connected to the heat sink via TIM (Thermal interface material).

MingFa recommends the use of a high thermal conductive interface between the LED module and the LED cooler.

Either thermal grease, A thermal pad or a phase change thermal pad thickness 0.1-0.15mm is recommended.

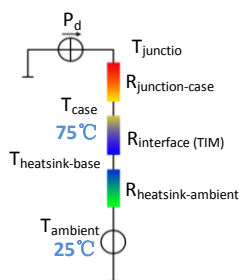

*Thermal resistance is a heat property and a measurement of a temperature difference by which an object or material resists a heat flow.

Geometric shapes are different, the thermal resistance is different. Formula: $\theta = (T_{hs} - T_a) / P_d$

θ - Thermal Resistance [°C/W]; T_{hs} - Heatsink temperature; T_a - Ambient temperature;

*The thermal resistance between the junction section of the light-emitting diode and the aluminum substrate side of the package outer shell is R_{junction-case}, the thermal resistance of the TIM outside the package is R_{interface (TIM)} [°C/W], the thermal resistance with the heat sink is R_{heatsink-ambient} [°C/W], and the ambient temperature is T_{ambient} [°C].

*Thermal resistances outside the package R_{interface (TIM)} and R_{heatsink-ambient} can be integrated into the thermal resistance R_{case-ambient} at this point. Thus, the following formula is also used:

$$T_{\text{junction}} = (R_{\text{junction-case}} + R_{\text{case-ambient}}) \cdot P_d + T_{\text{ambient}}$$